

ADAYO

2-DIN DVD MULTIMEDIA STATION
BUILT-IN NAVIGATION / BLUETOOTH

CE4M01D

OWNER'S MANUAL

Safety Precautions

Thank you for purchasing this product. Please read through these operating instructions so you will know how to operate your model properly. After you've finished reading the instructions, keep this manual in a safe place for future reference.

Only connect the unit to a 12-volt power supply with negative grounding.

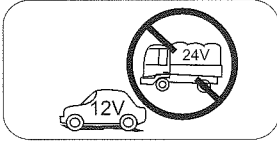

Never install this unit where the operation & condition for safe driving is impaired.

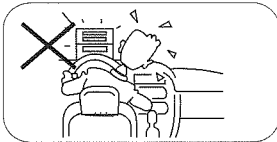

Never use the video display function in the front when driving to prevent the violation of laws & regulations and also to reduce the risk of traffic accident except for using rear view video camera.



Never expose this unit, amplifier, and speakers to moisture or water to prevent electric sparks or fire.

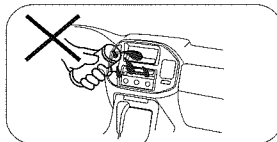

Please don't change the fuse on the power cord without professional guidance, using improper fuse may cause damage to this unit or even cause fire.

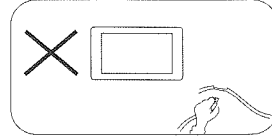

Please contact your nearest dealer if one of the following symptoms is experienced:

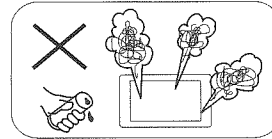

- Water or other objects enters the unit.
- There is smoke.
- Peculiar smell.

To ensure safe driving, please adjust the volume to a safe and comfortable level in case of emergency situations.

Safety Precautions

1. Never disassemble or adjust the unit without any professional guidance.
For details, please consult any professional car shop / dealer for inquiry.
2. If the front panel or TFT monitor is dirty, please use a clean silicone cloth and neutral detergent to wipe off the spot. Using a rough cloth and non-neutral detergent such as alcohol for cleaning may result in scratching or decoloration to the monitor.
3. If any abnormal behavior of the unit is found, please refer to trouble shooting guide of this manual. If no relevant information is found, please press the [RESET] key on the front panel to resume factory default.
4. If you have parked the car in hot or cold weather for a long time, please wait until the temperature in the car becomes normal before operating the unit.
5. Using the car heater in low temperature environment may result in moisture inside the unit, DO NOT use the unit in this situation. Eject the disc and wipe off the moisture on the disc. If the unit still doesn't work after a few hours, please contact the service center.
6. Do not impact the LCD monitor which could cause damage.
7. To prevent damage to the screen, avoid touching it with sharp objects.
8. To provide a clear demonstration and an alternative for easy understanding to the operation of this unit, graphic illustrations are used.
However, some illustrations are different from the actual images displayed on the screen.
9. Operate the unit correctly according to this manual to prevent unnecessary problem. The guarantee won't be valid if the problem is caused by inappropriate operation.

Expanding Systems

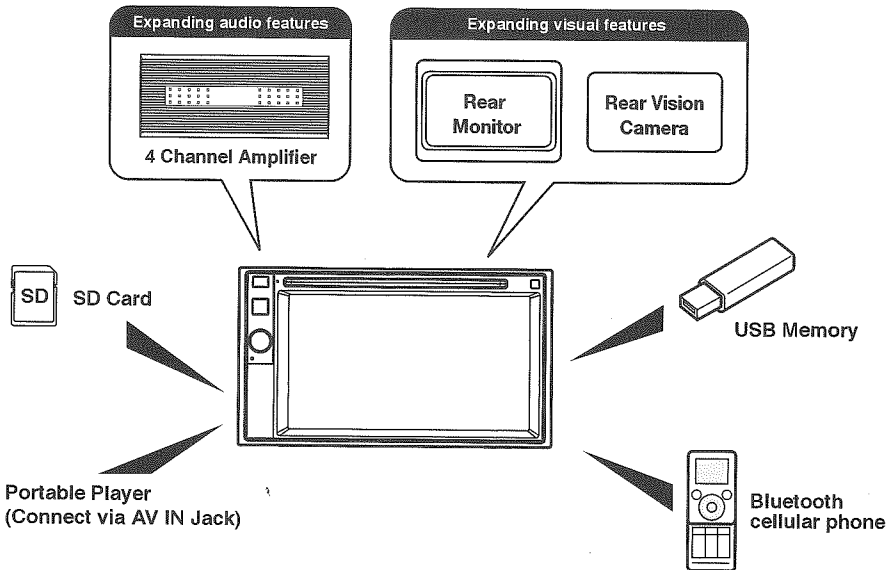

Note:

The items listed outside of the frame are the commercial products generally sold.

Contents

Safety Precautions	1	Pair the Bluetooth-enabled Devices	14
Contents	3	Disconnect Bluetooth Device	14
Before Using	4	Make a Call	14
Basic Operations	5	Receive a Call	15
Parking Brake Inhibit	5	Adjust Bluetooth Settings	15
Mute	5	Settings	16
Power On / Off	5	Display System	16
Audible Beep Confirmation	5	Adjust General Settings	16
Playing Source Selection	5	Adjust Video Settings	16
Volume Adjustment	5	Adjust Time Settings	17
EQ Menu	5	Adjust DVD Rating	17
Select Preset Equalizer	6	Adjust Bluetooth Settings	17
Adjust EQ Parameters	6	Adjust sound settings	18
Adjust FAD BAL	6	Adjust Volume Settings	18
Set Date /Time	7	System Settings	18
Set Date	7	Other Modes	19
Set Clock Mode	7	Listen to Other Devices	19
Set Time	7	Reset	19
Radio Mode	8	Replace a Fuse	19
Radio Display	8	GPS	19
Select Radio as Playing Source	8	Specifications	20
Select One Radio Band	8	Troubleshooting	22
Tune	8	Installation	23
Preset Station	9	Wire Connections	25
Local Seeking	9		
EQ Selection	9		
Playback Mode	10		
Load a Disc	10		
Eject a Disc	10		
Touch Screen Controls	10		
Controlling Playback	10		
Connect a USB Device	10		
Remove a USB Device	10		
Insert a SD Card	10		
Remove a SD Card	10		
Play/Pause	10		
Previous/Next	11		
Search for a Folder	11		
Repeat	11		
Repeat A-B	12		
Shuffle (Random) Play	12		
Select Audio Mode	12		
Select Subtitle Language	12		
Video Setup	12		
Playback Information	13		
Direct Track Entry	13		
Rotate Pictures	13		
Zoom	13		
Bluetooth Mode	14		

Before Using

Front Panel

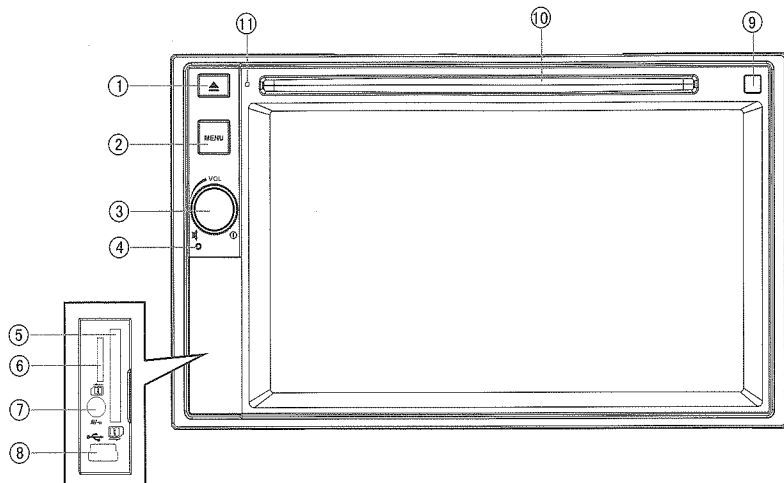

Notice:

The graphic in this manual is for reference only, and may be different from the actual unit. Reference to actual unit is suggested.

1. [▲] Button

Press to eject a disc.

2. [MENU] Button

Press to switch between the main menu and current source.

3. [VOL/Ⓞ/🔇] Knob

Rotate to adjust the volume.

Press momentarily to activate the MUTE function. Press again to resume normal listening.

Press to turn the unit ON. Press and hold to turn the unit OFF.

4. Reset Button

Press to reset system settings to factory default (except password and parental lock settings).

5. SD card slot

6. Map Slot

The MicroSD card is used for the Navigation Map only, not for music or other files.

This may be used for firmware updates if required.

7. A/V Input

Accepts a 3.5mm jack through which signals from various audio/video devices can be applied to the unit.

8. USB connector

9. Remote Sensor

10. Disc slot

11. Microphone

Basic Operations

Parking Brake Inhibit

- When the "BRAKE" cable is connected to the brake switch, the display on the TFT monitor will display video only when the vehicle is applied.
- Parking brake function is overridden when the video source is set to REVERSE.
- When the parking brake inhibit is active, the front monitor displays "Warning!!! It is illegal to view video while driving or operating a motor vehicle". Preventing the driver from watching content while driving. Rear video output is not affected.

Mute

Press [VOL/⓪/🔇] knob to mute the volume from the unit. Press again to restore the volume. Adjusting the volume or using any of the audio setup features cancels the mute function.

Power On / Off

Press the [VOL/⓪/🔇] knob on the unit to turn the unit on. The buttons on the front of the unit light up for a moment and the current mode status appears in the LCD. Press and hold the [VOL/⓪/🔇] knob to power off the unit.

Audible Beep Confirmation

An audible beep tone confirms each function selection. The Beep tone can be disabled through the Setup menu.

Playing Source Selection

Press the [MENU] button on the front panel to change between available playing sources. The playing mode is displayed on the screen.

1. ← or →: Touch this page button to view the first or second page of on-screen buttons
2. Function icons
3. Show current player source and Date
4. Settings: Touch to access system settings menu.
5. Custom: Touch to access Equalizer level settings menu.

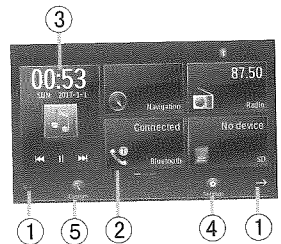

Volume Adjustment

To increase or decrease the volume level, rotate the [VOL/⓪/🔇] knob on the front panel. The volume ranges from "0" to "50". The LCD or TFT screen displays the volume level for 3 seconds.



EQ Menu

The Audio Control feature allows you to easily adjust your audio system to meet the acoustical characteristics of your vehicle, which vary depending on the type of vehicle and its measurements. Proper setting of the Fader and Balance boosts the effects of the cabin equalizer.

Select Preset Equalizer

1. Enter the EQ setup mode
Touch the [EQ] icon in the user interface and the EQ setup interface will display on the screen.
2. Select EQ mode
Touch the desired EQ selection: [User] / [Flat] / [Classic] / [Rock] / [Jazz] / [Techno] / [Pop], and the EQ mode will change.

Adjust EQ Parameters

To adjust EQ parameters, touch and drag the parameters adjustment bar.

- [Loud: On/Off]: When listening to music at low volumes, this feature will selectively boost certain bass and treble frequencies.

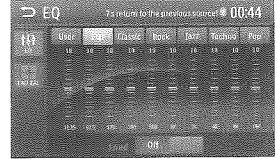

Adjust FAD BAL

You can adjust front/back/left/right balance of the speaker and the subwoofer volume to get balanced listening effect according to the surroundings and your interest.

1. Enter the EQ setup mode
Touch the [FAD BAL] icon in the user interface and the EQ setup interface will display on the screen.
2. Adjust subwoofer volume
Touch [◀] / [▶] to adjust subwoofer volume from -12 to +12.
3. Adjust fade / balance value
Touch [▲] / [▼] / [◀] / [▶] to adjust fade / balance value from -20 to +20.
[▲]: Front speaker
[▼]: Rear speaker
[◀]: Left speaker
[▶]: Right speaker

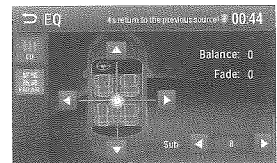

Notes:

1. The parameters of the EQ modes has been preset and you can not change them besides 'User'.
2. The EQ mode will change to 'User' automatically when you adjust the frequency value under the modes besides 'User'.
3. The value of Sub is independent of EQ mode and can be adjusted separately.

Set Date /Time

1. Touch [Settings].
2. Touch [Time].

The date/time setup menu is displayed.

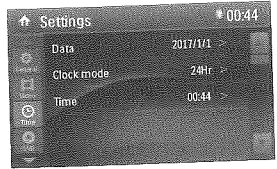

Set Date

1. Touch [Date].
2. Touch the date information on the screen .
A submenu is displayed.
3. Touch [▲] or [▼] to set year, month and day.

Set Clock Mode

1. Touch [Clock mode].
2. Touch [12Hr] or [24Hr] to switch clock mode.

Set Time

1. Touch [Time].
2. Touch the time on the screen, a submenu is displayed.
3. Touch [▲] or [▼] to set hour and minute.

Tip:

When date/time is set, touch [Save] to confirm or [Cancel] to exit.

Radio Mode

Radio Display

1. Touch to view the SOURCE MENU.
2. To view all the stored stations
3. Preset stations list of current band
4. Clock
5. Current station frequency
6. Current radio band
7. Touch to view more buttons
8. Tune backward(long press, then short press briefly)
9. Search stations automatically
10. Tune forward(short press)
11. Touch to change band
12. Save the desired radio station
13. Touch to receive Local or Distant stations
14. Enter frequency directly
15. Touch to access Equalizer settings menu

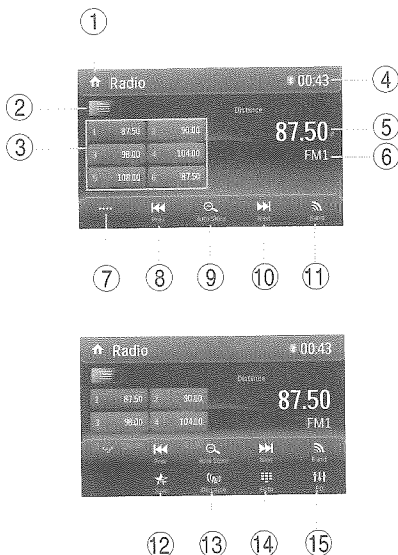

Select Radio as Playing Source

Open the Source Menu and then touch [Radio].

Select One Radio Band

Touch the [📶] icon on the user interface to select one radio band among FM1, FM2, FM3, AM1 and AM2.

Tune

Auto Tuning

Touch and hold [⏮] / [⏭] icon on the user interface more than 1 second to seek a higher / lower station.

To stop searching, repeat the operation above or press other keys having radio functions.

Note:

When a station is received, searching stops and the station is played.

Manual Tuning

Method 1:

During manual tuning, the frequency will be changed in steps.

Touch the [⏮] / [⏭] icon on the user interface to tune in a higher / lower station.

Method 2:

1. Touch the numeric keypad icon [🔢]. Numeric keyboard is displayed, touch number to input frequency.
2. Touch [✖] to delete the input number step by step.
3. Touch [OK] to enter.



Radio Mode

Preset Station

The unit has 5 bands, such as FM1, FM2, FM3, AM1, AM2, and each band can store 6 stations; hence the unit can store 30 stations in total.

Search Stations Automatically

Touch [🔍] to search station and store 6 strongest stations in current band automatically.

Manual Store

1. Tune to a station.
2. Touch [★].
3. Touch one of the channels P1 to P6 to save the select band.

Tune to a Preset Station

1. Touch [☰].
2. Select a band.
3. Touch one of the preset channels (P1 to P6) on the screen.

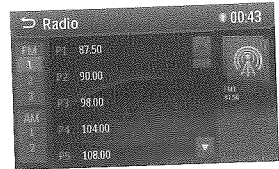

Local Seeking

Touch the [📶] icon and choose the Radio Local or Distance. When the [📶] icon turns bright, only stations with a strong signal strength will be detected. Default is "Distance".

EQ Selection

Press the [🔊] icon to enter the EQ setup menu.

Playback Mode

Load a Disc

You can play video, audio or images stored on the following discs:

- DVD Video, DVD-R, DVD-RW
- VCD
- Audio CD, CD-R, CD-RW

Note:

Ensure that the disc contains playable content.

Eject a Disc

Press the [Δ] key on the front panel to eject the disc. When the disc is ejected, the unit switches to the previous source.

Touch Screen Controls

The touch key areas for DVD playback are outlined below:

- A: Return to the main menu
- B: Play the video and display playback information
- C: Display onscreen control menu
- D: Time display

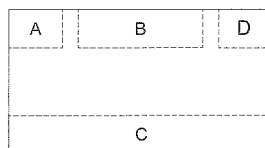

Controlling Playback

To access the on-screen controls, touch the screen except upper left corner, and touch again to cancel display. Touch [$\bullet\bullet\bullet\bullet$] to view all function icons.



Connect a USB Device

1. Open the USB door.
2. Insert the small end of the USB cable to the 3.5 jack and USB socket, then connect the other end of the cable to your USB device.

Remove a USB Device

1. Select other source on the main menu.
2. Remove the USB device.



Insert a SD Card

1. Open SD card cover.
2. Insert the SD card into the SD card slot.
Play starts automatically.

Remove a SD Card

1. Select other source on the main menu.
2. Press the card until you hear a click sound.
3. Remove the SD card.

Play/Pause

1. Once a disc, USB or SD card is inserted, play starts automatically.

Playback Mode

- For DVD movie, if a menu appears, press [▶] to start play.
- To pause, touch [⏸].
To resume play, touch [▶].
- Skip to previous / next track / chapter, press [⏮] / [⏭] key.

Previous/Next

Touch [⏮] / [⏭] key on the screen to skip to previous / next track / chapter.

Search for a Folder

For Video Files

- Touch [📁] to display all available video folders.
- Touch a folder, then select the desired file.
- Touch the file again to start play.

For Audio Files

- Touch [🎵] to display all available audio folders.
- Touch a folder, then select the desired file.
- Touch the file again to start play.

For Picture Files

- Touch [🖼️] to display all available picture folders.
- Touch a folder, then select the desired file.
- Touch the file again to start play.

For Folder Control

- Touch [🔍] to display all available folders.
- Touch a folder, then select the desired file.
- Touch the file again to start play.

Repeat

For DVD/VCD movie disc:

- Touch bottom half of the screen to display menu on the screen, if necessary.
- Touch [⋯] to display the 2nd menu.
- Touch [↔️] repeatedly to select:

DVD

[↔️] Repeat chapter: Play the current chapter repeatedly.

[↔️] Repeat title: Play all chapters in the title repeatedly.

[↔️] Repeat all: Play all in the disc repeatedly.

[↔️] Repeat off: Cancel repeat play.

VCD

[↔️] Repeat single: Play the current single repeatedly.



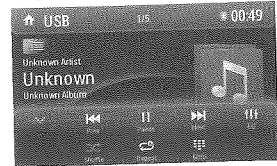

[↔️] Repeat all: Play all in the disc repeatedly.

[↔️] Repeat off: cancel repeat play.



Playback Mode

For CD/MP3 files:

1. Touch anywhere except the upper left corner to display menu on the screen, if necessary.
2. Touch [] repeatedly:
 - [] Repeat all: Play all tracks repeatedly.
 - [] Repeat folder: Play all in the current folder.
 - [] Repeat single: Play the current single repeatedly.
 - [] Repeat off: Cancel repeat play.



Repeat A-B

You can repeat a specific of video file (repeat A-B).

1. Touch the screen to display control menu, if necessary.
2. Touch [] to display the 2nd menu, if necessary.
3. Touch [A-B] repeatedly to mark:
 - Repeat A-: the start of the section to repeat.
 - Repeat A-B: the end of the section to repeat.
 - The selected section plays repeatedly.
4. To exit A-B repeat mode, touch A-B until [Repeat A-B off] displayed.



Shuffle (Random) Play

You can play audio tracks/files in random order.

1. Touch the screen to display control menu, if necessary.
2. Touch [] to display the 2nd menu, if necessary.
3. Touch [] on the screen repeatedly to turn random play on or off.



Select Audio Mode

When you play VCDs, you can select an audio mode (R/L/Stereo).



1. During play, touch bottom half of the screen to display menu on the screen, if necessary.
2. Touch [] to display the 2nd menu.
 - Touch [] repeatedly until the audio mode is selected.

Select Subtitle Language

For DVD discs that contain two or more subtitle languages.

1. During play, touch the screen to display menu on the screen, if necessary.
2. Touch [] to display the 2nd menu.
3. Touch [] repeatedly to select a language.
 - The selected language is displayed.

Video Setup

Touch [] to access video setup mode, touch [] or [] to set the desired effect.

You may set the brightness, contrast, saturation, and hue of the video output from 1 to 20.

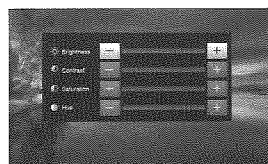

Playback Mode

Playback Information

Touch the screen when playing back DVD and VCD discs and the playback information will be displayed on the top area of the TFT.

For DVD

1. Disc type.
2. DVD Title information. "01/08" indicates that this DVD has 8 titles and the title playing back now is the first title.
3. DVD Chapter information. "005/012" indicates that current title has 12 chapters and the chapter playing back now is the fifth chapter.

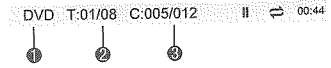

For VCD

1. Disc type.
2. VCD Track information. "01/08" indicates that this VCD has 8 tracks and the track playing back now is the first title.

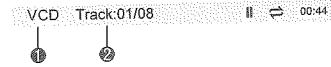

Elapsed Time

1. Elapsed time of the current track.
2. Total time of the current track.



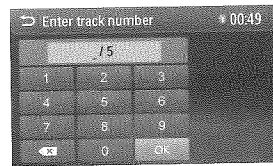

Direct Track Entry

To select a track directly, touch the [] icon on screen control to display the direct entry menu. Enter the desired track using the on-screen number pad. Press [OK] to the selected track.





Rotate Pictures

1. When you view pictures, touch the screen to display menu on the screen, if necessary.
2. Touch [] to display the 2nd menu.
3. Touch [] repeatedly to rotate the picture.

Zoom

You can zoom in pictures for a close view.

1. When you view pictures, touch the screen to display menu on the screen, if necessary.
2. Touch [] to display the 2nd menu.
3. Touch [] repeatedly to zoom in the picture.

Bluetooth Mode

You can make or receive phone calls with Bluetooth-enabled phones through the unit. You can also listen to music from a Bluetooth-enabled device.

Pair the Bluetooth-enabled Devices

To connect your Bluetooth device to the unit, you need to pair the device to the unit. Pairing needs only to be done once. You can pair up to five devices. You also can search for Bluetooth devices by mobile phone.

1. Turn on the Bluetooth function on the mobile phone.
2. Touch [] to search for Bluetooth device with the unit.
3. Select the Bluetooth device ID in the pairing list.
4. Enter default password "0000".

Tip:

- The operational range between this unit and a Bluetooth device is approximately 5 meters .
- Before you connect a Bluetooth device to this unit, familiarize yourself with the Bluetooth capabilities of the device.
- Compatibility with all Bluetooth device is not guaranteed.
- Any obstacle between this unit and a Bluetooth device can reduce the operational range.
- Keep this unit away from any other electronic device that may cause interference.

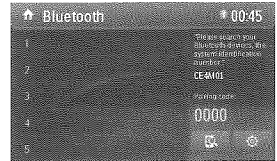

Disconnect Bluetooth Device

To disconnect one device, touch [] .

Tip

- The device will also be disconnected when the device is moved beyond the operational range.
 - If you want to reconnect the device to the unit, place it within the operational range.
 - If you do not want to reconnect the device to the unit automatically, touch [], then set [Auto connect] to [Off].
- For details, see the "Adjust Bluetooth Settings" section.



Make a Call

1. Select Bluetooth function in the home menu.
2. Pair the phone with the unit.
3. Search for phone number from the following list:
 - [Phone Book]
 - [Call Log]
 - [Missed calls]
 - [Received calls]
 - [Dialed calls]

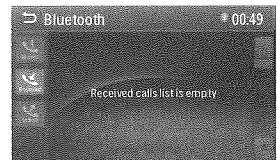

Or touch the number pad directly, then touch [] to dial.





Bluetooth Mode

Receive a Call

By default, all incoming calls are received automatically.

1. If there is an incoming call, the screen will appear "Incoming".
2. You may touch the screen to select [Hang up] or [Answer].

Speak into the Bluetooth microphone.

- Touch[] to hang up the call.
- Touch[] to mute the microphone
- Touch[] to transfer the call to your mobile phone.
- Touch[] to show the key pad.

Tip

- You can select to receive calls manually by set [Auto answer] to [Off] status.

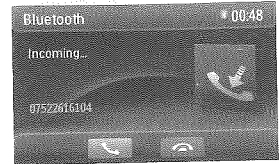
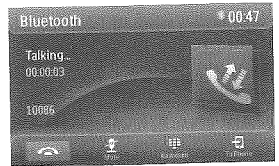

Adjust Bluetooth Settings

1. In Bluetooth menu, touch [].

The option menu is displayed.

2. Touch on the selected option to change the setting.

- [Bluetooth]: To turn on or off "Bluetooth" function.
- [Auto connect]: To turn on or off "Auto connect" function.
- [Auto answer]: To turn on or off "Auto answer" function.
- [Pairing code]: To set pairing code.
- [Phone sync]: To synchronize phone book, touch [OK] on the sub-menu popped out.

Phonebook sync may take several minutes to load on initial setup.

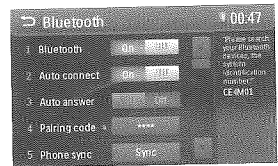

Tip

- You can also adjust Bluetooth settings in the "Settings" menu.

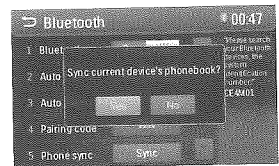

Music Mode

A2DP

A2DP is short for Advanced Audio Distribution Profile. The mobile phones supporting this function can transmit stereo audio, whereas the ones not supporting this function can transmit mono audio only.

AVRCP

AVRCP is short for Audio/Video Remote Control Profile. The mobile phones supporting this function can control the playback of a Bluetooth audio player.

In the mode of the music player working, if you want to make a phone call, you can press the number keys on the mobile phone. At the same time the music player will stop. The TFT screen will display "Calling", after the call received, the voice will be transferred to the unit. When the call ends, the screen will display music playing menu.

If there is an incoming phone call, the music player will stop, and the screen will display "Incoming". When the call ends, the screen will display music playing menu.



Display System

1. Touch the upper left corner to display main menu.
2. Touch [Settings].
The settings menu is displayed.
3. Touch the upper left corner of the screen to exit.

Adjust General Settings

1. Touch [General], if necessary.
2. Touch to highlight an option.
3. Touch the option to adjust it.

General settings	Options	Description
Radio region	Select one that matches your location.	
Sensitivity	Local	Select Local to receive only stations with extremely strong signal.
	Distance	
Blackout	Off/10s/20s	Set the screensaver.
Dimmer mode	Night/Dark/Normal/Bright	Adjust the display brightness.
OSD	Select on-screen display language.	
Beep	On	Turn on the beep sound. Each time you press a button, the unit beeps.
	Off	Turn off the beep sound.
Calibration	Start	Calibrate the touch screen.
TTS	On/Off	
TTS sound	Small/Middle/Big	
TTS speaker	Female/Male	

4. Touch the upper left corner of the screen to exit.

Calibration

When the touch operation is not sensitive or valid, you should calibrate the touch screen through calibration setting function. Adjust the response positions of the touch panel as followings:

1. Press the [Calibration] option on the setup menu to enter.
2. Touch [Start] to enter.
3. Press and hold the center of [+] for 2 seconds, the [+] will move automatically.
4. Aim at center of [+], follow the path as shown of the figure, after steps from 1 to 5, the system will exit calibrating automatically.

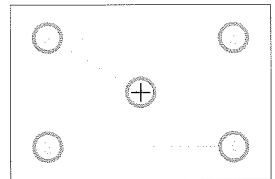

Adjust Video Settings

1. Touch [Video].
2. Touch the option to select:

Video settings	Options	Description
Parking	On	Disable video
	Off	Enable video

3. Touch the upper left corner of the screen to exit.

When in Park "On" mode, the screen will display "WARNING" [if you play the video disc]. The above warning screen will prevent the driver watching images.

Settings

Adjust Time Settings

1. Touch [Time].
2. Touch an option repeatedly to select:

Time settings	Options	Description
Date	Y/M/D	Touch [▲] or [▼] to set year, month and day.
Clock mode	12Hr/24Hr	Touch [12Hr] or [24Hr] to switch clock mode.
Time	H/M/AM/PM	Touch [▲] or [▼] to set hour and minute. Touch [▲] or [▼] to set AM/PM (only for 12Hr).

3. Touch the upper left corner of the screen to exit.

Adjust DVD Rating

1. Touch [DVD].
2. Touch an option repeatedly to select.
3. Touch the upper left corner of the screen to exit.

DVD rating	Options	Description
Set password		Set password to restrict the play of discs. The default password is 0000.
Rating level	Kid safe	Acceptable for children.
	G	Acceptable for general viewers.
	PG	Parental guidance suggested.
	PG-13	Unsuitable for children under age 13.
	PG-R	Recommend parents to restrict children under 17 to view.
	R	Restricted recommend parents to guide children under 17 to view.
	NC-17	Unsuitable for children under age 17.
	Adult	Acceptable for adults only.

3. Touch the upper left corner of the screen to exit.

Adjust Bluetooth Settings

1. Touch [Bluetooth].
2. Touch an option repeatedly to select.

Bluetooth settings	Options	Description
Bluetooth	On	Turn on the Bluetooth function.
	Off	Turn off the Bluetooth function.
Auto connect	On	If the pre-paired device is within the effective range, the unit re-connects to pre-paired device automatically.
	Off	Need to re-connect manually.
Auto answer	On	Answer paired phone call automatically.
	Off	Answer phone call manually.
Pairing code		Set the password for pairing the unit with other Bluetooth device.

3. Touch the upper left corner of the screen to exit.

Settings

Adjust sound settings

1. Touch [Sound].
2. Touch an option to select:

Sound settings	Options	Description
Sub woofer	On	Turn on the subwoofer.
	Off	Turn off the subwoofer
Sub woofer filter	80Hz	Select subwoofer filter criteria.
	120Hz	
	160Hz	
DRC	On/Off	Dynamic range compression on or off.

3. Touch the upper left corner of the screen to exit.

Adjust Volume Settings

You can set different volume for different modes.

1. Touch [Volume].
The volume setting sub-menu is displayed.
2. Touch on a source.
3. Touch [▲] or [▼] to assign value: 0 to 12.
When switching to the source, the volume increases automatically.
4. Touch the upper left corner of the screen to exit.

System Settings

Load factory:Restore to default settings.

Other Modes

Listen to Other Devices

You can connect an external audio/video device to the unit.

1. Connect the external device with the supplied AV cable.
2. Touch the upper left corner to display the main menu.
3. Touch [AV-IN 1]/[AV-IN 2] to access external device.

Reset

When the unit hangs up, you can reset it.

Press [RESET] with a ball-point pen or similar tool.

Tip

When the unit has been reset, all the settings will return to default settings.

Replace a Fuse

If there is no power, the fuse may be damaged and need to be replaced.

1. Take out the unit from dashbord.
2. Check all electrical connections.
3. Buy a fuse that matches the amperage of the damaged fuse.
4. Replace the fuse while the units power is disconnected.

GPS

1. Touch the upper left corner to display home menu.
2. Touch [Navigation], the navigation menu will display.
3. Refer to the map manual to operate the navigation tool.

Steering Wheel Control Programming

1. Touch the upper left corner to display home menu.
2. Touch [SWC], the SWC menu will display.
3. Adjust each key with a individual function.
4. Touch [Pair] to program.
5. Press each individual steering wheel control button for each corresponding function.
6. Once the final steering wheel control button is programmed, the functions are saved and the programming will end.
7. Touch [Reset] to reset the programming.

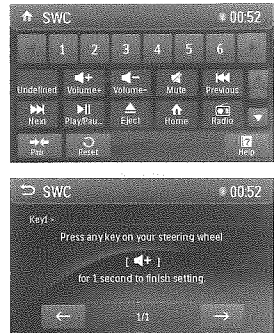
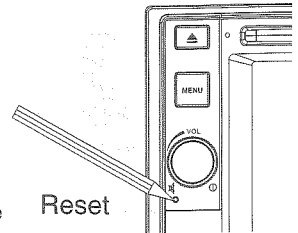

Specifications

General

Reference Supply Voltage.....	12V(DC)
Operating Voltage Range.....	10.5 - 15.8V(DC)
Max Operating Current.....	15A
Grounding System.....	Car Battery Negative Pole
Dimensions(WXHxD).....	178X101.5X160.5mm
Weight(main unit).....	1.75kg

FM

Signal Noise Ratio.....	≥ 55dB
Residual Noise Sensitivity (S/N=30dB).....	18dB μ V
Frequency Response (\pm 3dB).....	20Hz~12.5KHz
Station Seeking Level.....	20~28dB μ V
Distortion.....	≤ 1.0%
Stereo Separation (1KHz).....	≥ 25dB
Antenna Impedance.....	75 Ω

AM

Residual Noise Sensitivity (S/N=20dB).....	30dB μ V
Selectivity (\pm 9KHz).....	≥ 50dB

LCD

Screen size.....	6.2 inches(16:9)
Display resolution.....	800X480dots
Contrast ratio.....	4000:1

DVD Player

Signal / Noise Ratio.....	80dB
Dynamic Range.....	80dB
Distortion (line out).....	≤ 0.1%
Frequency Response (\pm 3dB).....	20Hz~20KHz
Maximum Output Power.....	4x41W
Load Impedance.....	4 Ω

AUX IN

Distortion.....	≤ 0.5%
Frequency Response (\pm 3dB).....	20Hz~20KHz
Audio Input Level.....	0.5Vrms

Audio

Audio Output Impedance.....	100 Ω
Audio Output Level.....	2Vrms(Max)

Video

Normal Video Input Level (CVBS).....	1.0 \pm 0.2V
Video Input Impedance.....	75 Ω
Video Output Impedance.....	75 Ω
Video Output Level.....	1.0 \pm 0.2V

Environment

Operating Temperature.....	-10°C ~ +60°C
Storing Temperature.....	-20°C ~ +70°C
Operating Humidity.....	45%~80%RH
Storing Humidity.....	30%~90%RH

Notice:

When the unit is operated to extremes, such as with maximum power output for a long time, or the temperature is over 70°C, it will enter heat protection mode, the volume will be reduced automatically. This is normal.

Specifications

Supported Formats:

- USB or memory file format: FAT16,FAT32
- Mp3 bit rate(data rate): 32-320 Kbps and variable bit rate
- Directory nesting up to a maximum of 8 levels
- Number of albums/folders: maximum 99
- Number of tracks/titles: maximum 999
- ID3 tag v2.0 or later
- File name in Unicode UTF8(maximum length:128 bytes)

Unsupported Formates:

- Empty albums:an empty album is an album that does not contain MP3 files,and is not be shown in the display.
- Unsupported file formats are skipped.For example,Word documents(.doc) or Mp3 files with extension.dlf are ignored and not played.
- AAC,WMM,PCM audio files

Supported MP3 Disc Format:

- ISO9660,Joliet
- Maximum title number: 512(depending on file name length)
- Maximum album number: 255
- Supported sampling frequencies: 32kHz,44.1kHz,48kHz
- Supported Bit-rates: 32-320Kbps and variable bit rate

Supported Video Formats:

- DVD
- RMVB
- MP4

Region Code

According to DVD sale region, the whole world is divided into six regions. A DVD disc can be played back only when its region code is compatible with that of the player in use.

Region 1: USA, Canada, East Pacific Ocean Islands;

Region 2: Japan, West Europe, North Europe, Egypt, South Africa, Middle East;

Region 3: Taiwan of China, Hong Kong of China, South Korea, Thailand, Indonesia, South East Asia;

Region 4: Australia, New Zealand, Mid & south America, South Pacific Ocean Islands/Oceania;

Region 5: Russia, Mongolia, India, Middle Asia, East Europe, North Korea, North Africa, North West Asia;

Region 6: China, Mainland.

Cautions when using Discs

1) DO NOT use irregular shaped disc.

2) Disc Cleaning

Use a dry, soft cloth to wipe the disc from center to edge, only neutral detergent can be used.

3) When playing a new disc

New disc may have some rough spots around the inner and outer edges. If such a disc is used, remove these rough spots with a pencil or ball-point pen, etc.

Troubleshooting

What appears to be trouble is not always serious. Please check the following points before calling a service center.

Problem	Cause	Corrective action
General		
Unit can not power on	Unit fuse blown.	Install new fuse with correct rating.
	Car battery fuse blown.	Install new fuse with correct rating.
	Illegal operation	Reset the unit.
No/low audio output	Improper audio output connection.	Check wiring and correct.
	Volume set too low.	Increase volume level.
	Speakers damaged.	Replace speakers.
	Heavily biased volume balance.	Adjust the channel balance to center position.
Poor sound quality or distortion	Speaker wiring is in contact with metal part of car.	Insulate all speaker wiring connections.
	Pirated disc is in use.	Use original disc.
	Speaker power rating does not match unit.	Replace speakers.
	Wrong connections.	Check wiring and correct.
Unit resets itself when engine is off	Speaker is shorted.	Check wiring and correct.
	Incorrect connection between ACC and BATT.	Check wiring and correct.
TFT monitor		
Warning information is shown at all times	Parking break wiring is not correct.	Check wiring and correct.
Flashing image or interference appears on screen	The color system of DVD disc does not match the monitor.	Adjust the color system of the DVD disc playing back or the monitor in use.
	Pirated disc is in use.	Use original disc.
	Video cable damaged.	Replace cables.
	Improper video signal connections.	Check wiring and correct.
Disc playback		
Cannot insert disc	A disc is already inside the unit.	Eject current disc and insert new one.
Disc does not play back	Disc is warped or scratched.	Use disc in good condition.
	Disc is dirty or wet.	Clean disc with soft cloth.
	Incompatible disc is used.	Use compatible disc.
	Disc is inserted upside down.	Insert disc with label side up.
	Disc region code is not compatible with unit.	Use disc with proper region code.
PBC cannot be used during VCD playback	PBC is not available on the disc.	Use disc with PBC available.
Repeat or search function is invalid during VCD playback	PBC is on.	Turn PBC off.
Error messages		
No disc	Disc is dirty.	Clean disc with soft cloth.
	Disc is upside down.	Insert disc with label side up.
	No disc inside.	Insert disc.
Bad disc	Disc is dirty.	Clean disc with soft cloth.
	Disc is upside down.	Insert disc with label side up.
Unknown disc	Disc format is not compatible with this unit.	Use disc with compatible format.
Region Error	DVD region code is not compatible with this unit.	Use disc with compatible region code.

Installation

Disconnecting the Battery

To prevent a short circuit, be sure to turn off the ignition and remove the negative (-) battery cable prior to installation.

Note:

If the unit is to be installed in a car equipped with an on-board drive or navigation computer, do not disconnect the battery cable. If the cable is disconnected, the computer memory may be lost. Under these conditions, use extra caution during installation to avoid causing a short circuit.

Remove Transport Screws

WARNING! Remove these two transport screws before installation. Otherwise, the DVD player will not work.

Replacing the Fuse

When replacing the fuse, use a new 15A replacement fuse. Using a fuse with an improper rating could damage the unit and cause a fire.

ISO-DIN Installation

This unit is designed to fit into a 2.0 DIN dashboard opening, found in many imported cars. The unit has threaded holes in the chassis side panels which may be used with the original factory mounting brackets of some vehicles to mount the radio to the dashboard. Please consult with your local car stereo specialty shop for assistance on this type of installation.

1. Remove the existing factory radio from the dashboard or center console mounting. Save all hardware and brackets as they will be used to mount the new radio.
2. Remove the factory mounting brackets and hardware from the existing radio and attach them to the new radio.

CAUTION! Do not exceed M5 X 6MM screw size. Longer screws may damage components inside the chassis.

3. Place the radio in front of the dashboard opening so the wiring can be brought through the mounting sleeve. Follow the wiring diagram carefully and make certain all connections are secure and insulated with wire nuts or electrical tape. After completing the wiring connections, plug the ISO connectors into the mating sockets on the rear of the chassis. Turn the unit on to confirm operation (vehicle ignition switch must be "on"). If the unit does not operate, re-check all wiring until the problem is corrected.

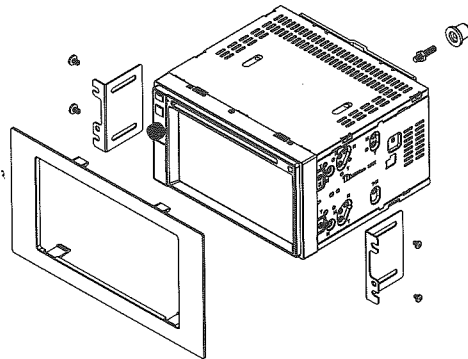

Installation

4. Mount the new radio assembly to the dashboard or center console using the reverse procedure in step 1.

CAUTION! Be careful not to damage the car wiring.

Note:

It is the end-users responsibility to install and operate this unit in a manner in accordance with local, state and federal laws. The PARKING BRAKE wire **MUST BE CONNECTED** as directed in the manual.

CAUTION!

Do not block the cooling fan exit. If blocked, the unit may overheat and become damaged.

Wire Connections

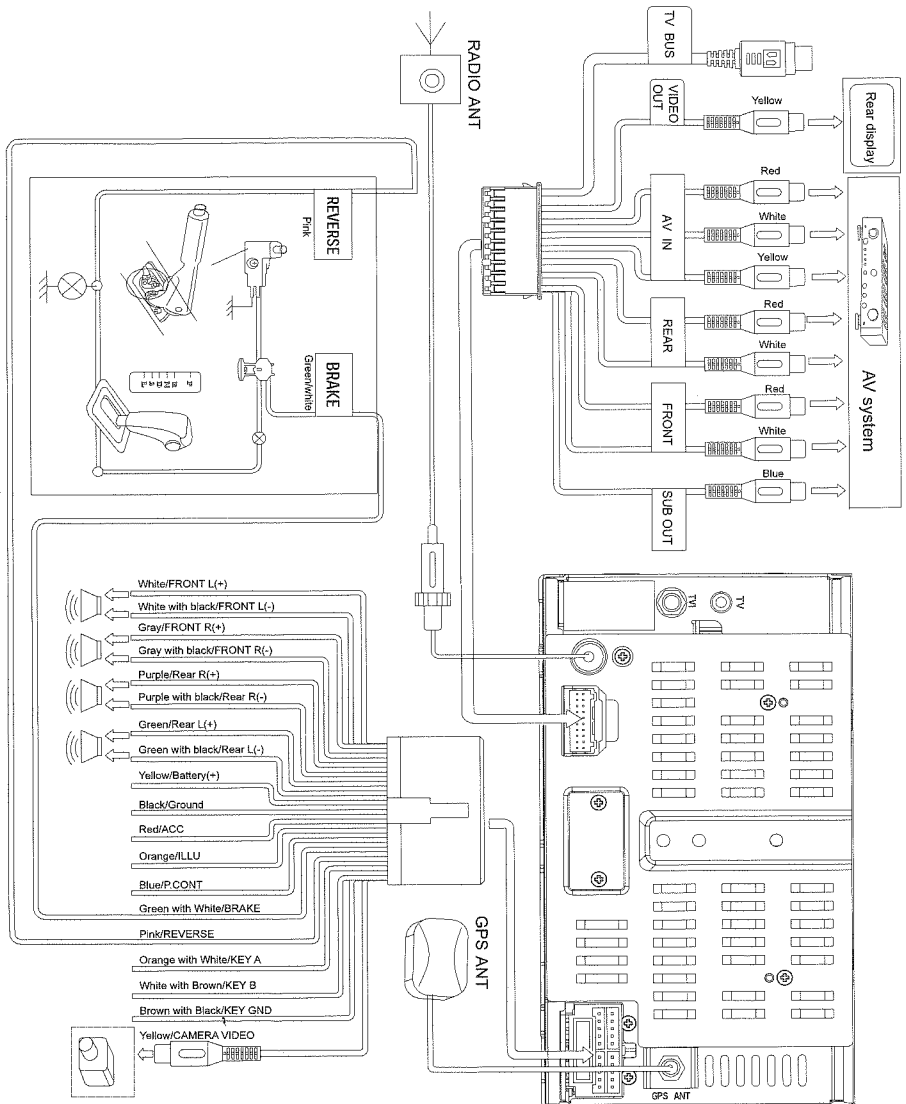

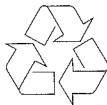

PN: 127075007281